

Varenummer: 23110111025

Beskrivelse: E+G Vertikal oliestandsglas  
HCK.176-GL-M12, for glycol-baserede løsninger

## Mål

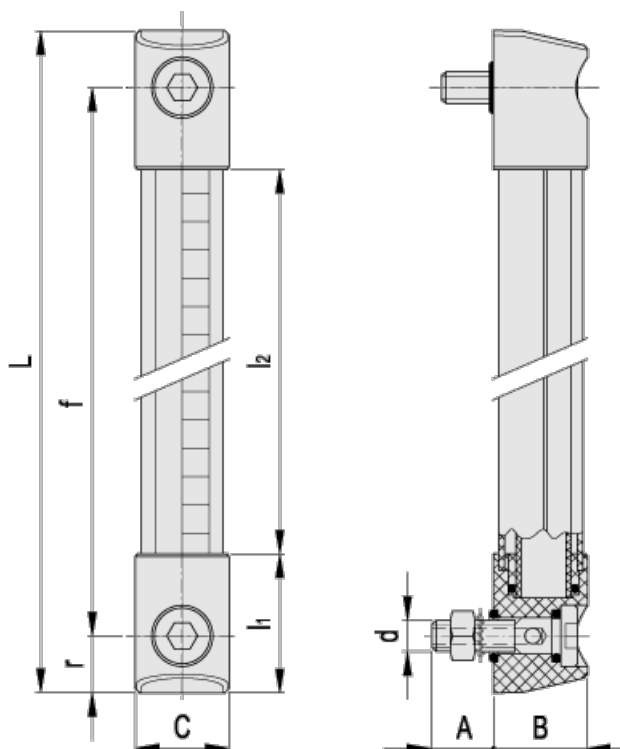

A = 20

r = 18.5

B = 33

C = 33

d = M12

f = 176

L = 213

l1 = 46.5

l2 = 120